

Infrared Halogen Heater Emitters

Type B/Bf

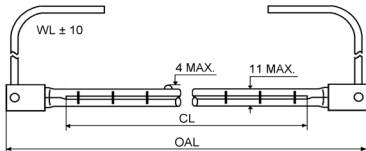

Type R7s

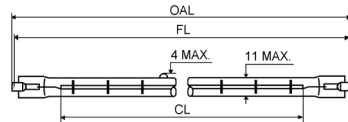

Type T

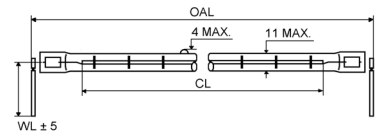

Type Jc

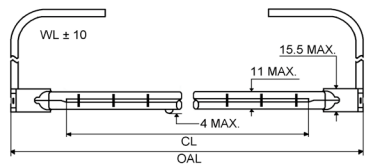

Type J

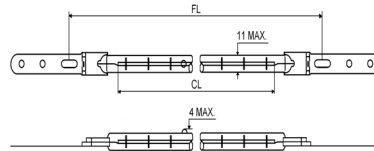

Type I

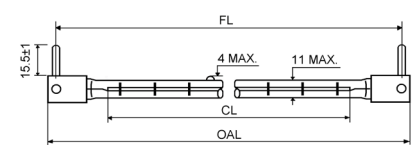

Base dimensions for Type B/Bf and I

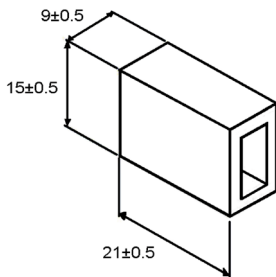

Metal clip dimension for Type J

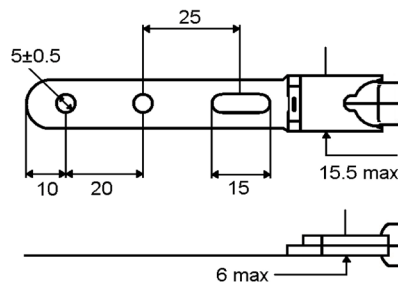

Thickness of Metal sleeve for Type Jc

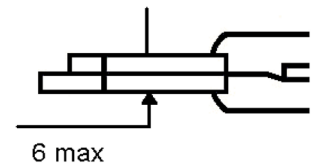

Base dimensions for Type B/Bf and I

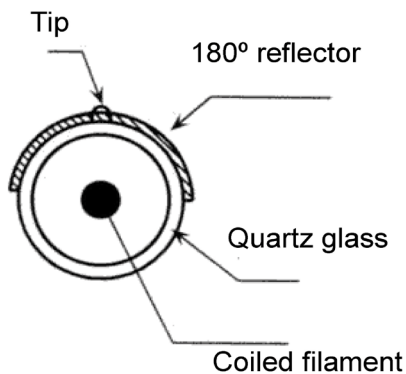

Metal clip dimension for Type J

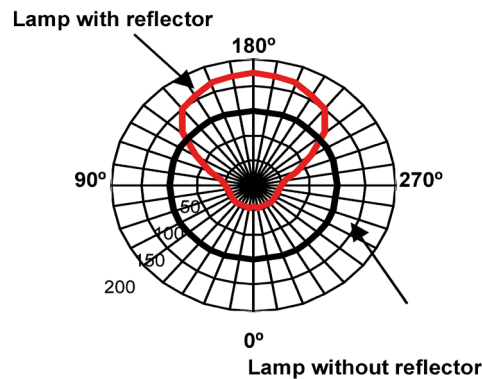

New Wireless Solution



ООО «CAO3»
+7 495 150-52-10

сайт: www.saoz.ru, почта: info@saoz.ru

Part code	Watts (W)	Volts (V)	Base Type	Overall length OAL (mm)	Fixation length FL (mm)	Heating length CL (mm)	Wire Length WL (mm)	Terminal	Color temp.(K)	Tube	Burning position	Ave. Life	Ordering code
300 WATTS													
JHS 230V 300W 60 RsH1-P	300	220-240	Rs	(117,6)	114,2±1,6	60±5	-	-	2450	Clear	Horizontal	5000	5JHS001
JHS 230V 300W 60 IH1	300	220-240	I	(120)	112±1	60±5	-	-	2450	Clear	Horizontal	5000	4JHS039
JHC 240V 300W 165 BfH	300	230-240	Bf	226 ± 2	-	165±5	220±10	Fork	2400	Reflector	Horizontal	5000	4JHC187
500 WATTS													
JHS 235V 500W 165 BfH	500	230-240	Bf	226 ± 2	-	165±5	220±10	Fork	2500	Clear	Horizontal	5000	4JHS229
JHC 235V 500W 165 BfH1	500	230-240	Bf	226 ± 2	-	165±5	200±10	Fork	2500	Reflector	Horizontal	5000	4JHC072
700 WATTS													
JHS 240V 700W 150 BfH1	700	230-240	Bf	210 ± 2	-	150±5	230±10	Splice	2620	Clear	Horizontal	5000	4JHS045
JHC 240V 700W 150 BfH1	700	230-240	Bf	210 ± 2	-	150±5	230±10	Splice	2620	Reflector	Horizontal	5000	4JHC150
1000 WATTS													
JHC 235V 1000W 272 BfH	1000	230-240	Bf	352 ± 2	-	272±5	220±10	Fork	2400	Reflector	Horizontal	5000	4JHC068
JHC 235V 1000W 272 BfU	1000	230-240	Bf	352 ± 2	-	272±5	200±10	Fork	2400	Reflector	Universal	5000	4JHC050
JHS 235V 1000W 272 JU	1000	230-240	J	-	370±10	272±5	-	-	2400	Clear	Universal	5000	4JHS056
JHC 235V 1000W 272 JH	1000	230-240	J	-	370±10	272±5	-	-	2400	Reflector	Horizontal	5000	4JHC008
JHC 235V 1000W 272 IH	1000	230-240	I	(354)	346±1	272±5	-	-	2650	Reflector	Horizontal	5000	4JHC048
JHC 400V 1000W 272 IU	1000	400	I	(354)	346±1	272±5	-	-	2550	Reflector	Universal	5000	4JHC069
1200 WATTS													
JHC 144V 1200W 155 JcH	1200	144	Jc	219 ± 3	-	155±5	160±10	Fork	2700	Reflector	Horizontal	5000	4JHC073
JHC 144V 1200W 155 BfH	1200	144	Bf	225 ± 2	-	155±5	150±10	Fork	2700	Reflector	Horizontal	5000	4JHC045
JHC 235V 1200W 155 BfH1	1200	230-240	Bf	225 ± 2	-	155±5	150±10	Fork	2700	Reflector	Horizontal	5000	4JHC043
JHC 240V 1200W 406 BfH	1200	230-240	Bf	499 ± 2	-	406±5	230±10	Splice	2400	Reflector	Horizontal	5000	4JHC107
JHC 240V 1200W 406 BfU	1200	230-240	Bf	499 ± 2	-	406±5	230±10	Splice	2400	Reflector	Universal	5000	4JHC111
1500 WATTS													
JHS 235V 1500W 280 BfH1	1500	230-240	Bf	352 ± 2	-	280±5	300±10	Splice	2400	Clear	Horizontal	5000	4JHS173
JHC 235V 1500W 280 BfH	1500	230-240	Bf	350 ± 1,2	-	280±5	230±10	Faston	2400	Reflector	Horizontal	5000	4JHC081
JHS 235V 1500W 385 RsH	1500	230-240	Rs	(446)	444±1,5	385±5	-	-	2400	Clear	Horizontal	5000	4JHS237
1600 WATTS													
JHC 144V 1600W 155 JcH	1600	230-240	Jc	219 ± 3	-	155±5	160±10	Fork	2700	Reflector	Horizontal	5000	4JHC028
JHC 144V 1600W 155 BfH	1600	230-240	Bf	225 ± 2	-	155±5	150±10	Fork	2700	Reflector	Horizontal	5000	4JHC046
JHC 235V 1600W 155 BfH1	1600	144	Bf	225 ± 2	-	155±5	150±10	Fork	2700	Reflector	Horizontal	5000	4JHC053
JHC 240V 1600W 406 BfH1	1600	144	Bf	485 ± 2	-	406±5	200±10	Fork	2500	Reflector	Horizontal	5000	EM-805
2000 WATTS													
JHC 235V 2000W 280 BfH	2000	230-240	Bf	353 ± 2	-	280±5	230±10	Splice	2400	Reflector	Horizontal	5000	4JHC005
JHC 235V 2000W 280 BfH2	2000	230-240	Bf	353 ± 2	-	280±5	210±10	Fork	2400	Reflector	Horizontal	5000	4JHC254
JHC 235V 2000W 280 BfU	2000	230-240	Bf	352 ± 2	-	280±5	200±10	Fork	2400	Reflector	Universal	5000	4JHC051
JHC 235V 2000W 280 BfU4	2000	230-240	Bf	353 ± 2	-	280±5	230±10	Splice	2400	Reflector	Universal	5000	4JHC104
JHS 235V 2000W 280 BfU1	2000	230-240	Bf	353 ± 2	-	280±5	230±10	Splice	2400	Clear	Universal	5000	4JHS141
JHS 235V 2000W 280 JU	2000	230-240	J	-	370±10	280±5	-	-	2400	Clear	Universal	5000	4JHS031
JHC 235V 2000W 280 JU	2000	230-240	J	-	370±10	280±5	-	-	2425	Reflector	Universal	5000	4JHC042
JHS 235V 2000W 280 TU3	2000	230-240	T	350 max.	-	280±5	120±5	Ring	2400	Clear	Universal	5000	4JHS061
JHS 400V 2000W 280 BfU1	2000	400	Bf	354 ± 2	-	280±5	300±10	Splice	2350	Clear	Universal	5000	4JHS232
JHS 400V 2000W 280 JU	2000	400	J	-	370±10	280±5	-	-	2400	Clear	Universal	5000	EM-65
JHC 400V 2000W 280 IU	2000	400	I	(354)	346±1	280±5	-	-	2700	Reflector	Universal	5000	4JHC123
JHC 235V 2000W 410 JH	2000	230-240	J	-	508±10	410±5	-	-	2400	Reflector	Horizontal	5000	4JHC247
JHS 235V 2000W 410 JH	2000	230-240	J	-	508±10	410±5	-	-	2400	Clear	Horizontal	5000	4JHS085
JHC 400V 2000W 410 BfU	2000	400	Bf	490 ± 2	-	410±5	230±10	Splice	2400	Reflector	Universal	5000	4JHC061
JHC 400V 2000W 410 JU	2000	400	J	-	508±10	410±5	-	-	2400	Reflector	Universal	5000	4JHC218
JHC 400V 2000W 410 JH	2000	400	J	-	508±10	410±5	-	-	2400	Reflector	Horizontal	5000	4JHC071
JHS 400V 2000W 410 JU	2000	400	J	-	508±10	410±5	-	-	2400	Clear	Universal	5000	4JHS032
JHC 230V 2000W 500 BfH	2000	230-240	Bf	650 ± 2	-	500±5	500±10	Splice	2400	Reflector	Horizontal	5000	4JHC041
JHC 235V 2000W 700 BfH	2000	230-240	Bf	787 ± 2	-	500±5	500±10	Splice	2240	Reflector	Horizontal	5000	4JHC189

Part code	Watts (W)	Volts (V)	Base Type	Overall length OAL (mm)	Fixation length FL (mm)	Heating length CL (mm)	Wire Length WL (mm)	Terminal	Color temp.(K)	Tube	Burning position	Ave. Life	Ordering code
2200 WATTS													
JHS 235V 2200W 280 BfU1	2200	230-240	Bf	350±2	-	280±5	150±5	Splice	2450	Clear	Universal	5000	4JHS037
JHS 235V 2200W 280 TU2	2200	230-240	T	345±1,5	-	280±5	145±5	Ring	2300	Clear	Universal	5000	4JHS234
2500 WATTS													
JHC 235V 2500W 280 BfH3	2500	230-240	Bf	353±2	-	280 ± 5	210±10	Fork	2700	Reflector	Horizontal	5000	4JHC027
JHC 235V 2500W 280 BfU	2500	230-240	Bf	352±2	-	280 ± 5	200±10	Fork	2700	Reflector	Universal	5000	4JHC259
JHC 400V 2500W 280 BH	2500	400	B	355±2	-	280 ± 5	210±10	Fork	2700	Reflector	Horizontal	5000	5JHC039
JHC 400V 2500W 315 BH	2500	400	B	378±2	-	315 ± 5	230±10	Splice	2500	Reflector	Horizontal	5000	5JHC001
JHS 480V 2500W 635 JcH	2500	400	Jc	723±3	-	635 ± 5	150±10	Splice	2500	Clear	Horizontal	5000	EM-818
3000 WATTS													
JHC 235V 3000W 280 BfU	3000	230 - 240	Bf	352±2	-	280±5	210±10	Fork	2700	Reflector	Universal	5000	EM-522
*JHS 235V 3000W 280 JU	3000	230 - 240	J	-	370±10	280±5	-	-	2200	Clear	Universal	5000	4JHS060
JHC 235V 3000W 280 JU	3000	230 - 240	J	-	370±10	280±5	-	-	2500	Reflector	Universal	5000	4JHC194
*JHS 235V 3000W 280 TU1	3000	230 - 240	T	350 max.	-	280±5	120±5	Splice	2200	Clear	Universal	5000	4JHS062
JHC 400V 3000W 280 BH	3000	400	B	355±2	-	280±5	210±10	Fork	2700	Reflector	Horizontal	5000	4JHC040
JHS 400V 3000W 280 IU	3000	400	I	(354)	346 ± 1	280±5	-	-	2600	Clear	Universal	5000	EM-1055
JHC 400V 3000W 280 IU	3000	400	I	(354)	346 ± 1	280±5	-	-	2600	Reflector	Universal	5000	4JHC165
JHS 400V 3000W 280 JU	3000	400	J	-	370 ± 10	280±5	-	-	2600	Clear	Universal	5000	4JHS053
JHS 400V 3000W 280 TU1	3000	400	T	350 max.	-	280±5	120±10	Ring	2550	Clear	Universal	5000	4JHS059
JHC 400V 3000W 315 BH	3000	400	B	378±2	-	315±5	230±5	Splice	2550	Reflector	Horizontal	5000	5JHC002
JHS 400V 3000W 410 JU	3000	400	J	-	508 ± 10	410±5	-	-	2400	Clear	Universal	5000	4JHS072
JHC 235V 3000W 700 BfH2	3000	230 - 240	Bf	787,5±2	-	700±5	500±10	Splice	2300	Reflector	Horizontal	5000	4JHC038
JHC 400V 3000W 700 BfH1	3000	400	Bf	784±2	-	700±5	200±10	Fork	2350	Reflector	Horizontal	5000	4JHC142
JHS 400V 3000W 700 IU	3000	400	I	(779)	771 ± 1	700±5	-	-	2400	Clear	Universal	5000	4JHS142
JHC 400V 3000W 700 IU	3000	400	I	(779)	771 ± 1	700±5	-	-	2350	Reflector	Universal	5000	4JHC149
JHS 400V 3000W 700 JU	3000	400	J	-	798 ± 10	700±5	-	-	2400	Clear	Universal	5000	4JHS049
JHC 400V 3000W 700 JU	3000	400	J	-	798 ± 10	700±5	-	-	2400	Reflector	Universal	5000	4JHC085
4000 WATTS													
JHC 400V 4000W 700 IU	4000	400	I	(782)	774 ± 1	700±5	-	-	2425	Reflector	Universal	5000	EM-1158
JHC 400V 4000W 700 BfH	4000	400	Bf	787,5±2	-	700±5	150±10	Ring	2400	Reflector	Horizontal	5000	RZ-197
4600 WATTS													
JHS 400V 4600W 236 THJHS 480V	4600	400	T	303 max.	-	236±5	155±5	Splice	3000	Clear	Horizontal	1000	4JHS075
4600W 236 TH	4600	480	T	290 max.	-	236±5	155±5	Splice	3000	Clear	Horizontal	1000	4JHS079
6000 WATTS													
JHS 480V 6000W 245 TH	6000	480	T	298 max.	-	245±5	41±3	Ring	3050	Clear	Horizontal	1000	4JHS220
JHS 480V 6000W 290 TH1	6000	480	T	350 max.	-	290±5	35±5	Ring	3025	Clear	Horizontal	1000	4JHS226
JHC 400V 6000W 1000 BfH1	6000	480	Bf	1125±2	-	1000±5	500±10	Stripped	2700	Reflector	Horizontal	1000	4JHC168

*Tube diameter is 13mm max

ООО «CAO3»
 +7 495 150-52-10
 сайт: www.saoz.ru, почта: info@saoz.ru